

# ALUTEC

## INSTALLATION INSTRUCTIONS

ENGLISH





▶ Safety instructions	04
▶ General notes	07
▶ Material & tool requirements	08
▶ System overview	10
▶ <b>INSTALLATION OF ALUTEC</b>	<b>11</b>
▶ Maintenance	27





## 2. SAFETY INSTRUCTIONS

### INTENDED USE

Creotecc mounting systems are solely intended for the purposes of mounting photovoltaic modules and associated anchoring systems on buildings or on the ground. To ensure that the mounting system is used correctly, the user must comply with the safety instructions and maintenance instructions (see chapter 7 „Maintenance“) listed in these installation instructions.

To comply with the requirements for intended use the user must adhere to these instructions and the installation guidelines provided by the module manufacturer. Among other aspects, this applies to the mechanical attachment of the modules, the maximum loads that the module is capable of withstanding and other details such as orientation, rear ventilation, cable routing, wiring, choice of inverter etc.

### INAPPROPRIATE USE

Any use other than those described in the previous paragraphs is regarded as inappropriate use.

All claims relating to damage incurred through inappropriate use will be rejected. Inappropriate use voids all liability, warranty and guarantee claims against the manufacturer and the user is liable for any damage to the mounting system incurred during the installation and operation of the system, as well as any subsequent damage to other parts of the system, the roof, the building and any personal injuries.

### GENERAL SAFETY INSTRUCTIONS

Read the installation instructions fully and carefully before commencing any installation work. Make sure you have understood all the installation steps and instructions. Clarify any questions before you start the installation, then proceed according to the instructions and complete the various steps in the correct order.

The mounting system must be installed by qualified personnel. Ensure that the personnel performing the installation have read and understood the installation instructions and the safety instructions and that they are aware of – and able to recognise – any potential dangers. The installation must comply with all industrial safety regulations, accident prevention requirements, norms, building regulations and other relevant directives. The connection of all electrical equipment must comply with the relevant VDE guidelines and the safety regulations specified by the electrical industry.

Safety clothing that complies with the relevant national regulations must be worn at all times during the installation.

Make sure there is always a second person present throughout the entire installation, who can provide assistance in the case of an accident.

Leave at least one copy of the installation instructions near the installation site for the personnel to refer to. Only use original parts and accessories authorised by the manufacturer.

Keep a copy of the installation instructions in a safe and accessible place for documentation and maintenance purposes.

## 2. SAFETY INSTRUCTIONS



### SPECIFIC SAFETY INSTRUCTIONS

#### SPECIFIC SAFETY INSTRUCTIONS FOR PHOTO-VOLTAIC MOUNTING SYSTEMS

- ▶ Ensure that the installation follows a plan drawn up by a professional. In particular, the configuration of the mounting system (selection of materials and components, width, thickness of fastening elements) must be appropriate for the site conditions (snow and wind loads, roof and module tilt angle, other factors such as atmospheric and chemical stress and, if applicable, earthquakes).
- ▶ For installations on buildings, all personnel must adhere to the relevant building regulations; among others these include the technical regulations of the roofing industry and the timber construction industry (DIN EN 1995 among others) and the steel construction industry (DIN EN 1993 among others). The structure must be able to withstand the additional load of the PV system.
- ▶ If there are no exact planning guidelines available, the manufacturer or the user can generate a design for the mounting system using software, or using the figures listed in these installation instructions. However, such measures are merely non-binding recommendations and are no substitute for a plan drawn up by a professional engineer.
- ▶ Before beginning the installation, check the plausibility of the structural design in relation to the local conditions. Ensure that the conditions of use specified in these installation instructions are adhered to.
- ▶ Take into consideration the installation guidelines for the other system components, e.g. modules, cables, plug connectors and inverters. When installing the cabling, you must comply with the relevant VDE guidelines and electrical industry safety regulations, as well as the

manufacturer's instructions regarding the modules, cables, plug connectors and inverters being used.

#### SPECIFIC SAFETY INSTRUCTIONS FOR WORKING ON ROOFS

- ▶ Secure the construction site to prevent unauthorised access.
- ▶ Safeguard the roof working space if the eaves height is 3 metres or more. Among other measures, this involves the installation of a personal fall protection system. If a fall protection system cannot be used for practical working reasons then a safety net for falling persons must be installed.
- ▶ If the installation of a safety net is impractical then a safety harness connected to suitable safety anchoring points may be used. However, this is only permissible for short-term work.
- ▶ Secure all objects on the roof against falling. The ground underneath the safety net must also be cordoned off. Check the load bearing capacity of the roof surface, the roof structure and other building components that will have to bear the weight of personnel or materials during the installation.



## 2. SAFETY INSTRUCTIONS

06

### SPECIFIC SAFETY INSTRUCTIONS FOR WORKING ON ELECTRICAL SYSTEMS

- ▶ Observe the relevant VDE regulations and guidelines.
- ▶ Be especially sure to observe the following instructions:
- ▶ Even at low levels of solar irradiation, photovoltaic modules generate significantly high voltages and series connections of several modules are designed for voltages of up to 1,000 volts. Touching open connectors can therefore increase the risk of an accident or even cause life-threatening electric shocks.
- ▶ For this reason you should establish the series connection of the modules as late as technically possible during the installation process, avoid lying or hanging cables and plugs and secure open electrical contacts against being touched.
- ▶ High DC currents flow in the circuits connected to photovoltaic modules and disconnecting these circuits can result in life-threatening arcing. Do not connect these circuits, e.g. to the inverter or generator junction box, until installation of the framing and modules has been completed. Always use the appropriate circuit breaker at the inverter or generator junction box to disconnect this circuit, e.g. for maintenance purposes.
- ▶ Do not perform any electrical connection work with moist or wet cable ends, sockets or plugs. Only install the modules under dry weather conditions.

### CLASSIFICATION OF DANGER NOTICES INTO DANGER CLASSES

- ▶ Dangerous situations are identified using corresponding danger notices in these installation instructions:
- ▶ Danger classes as per ANSI Z535.6-2006

▶ **DANGER** indicates a directly dangerous situation that can lead to death or serious injury if not avoided.



▶ **WARNING** indicates a possibly dangerous situation that can lead to death or serious injury if not avoided.



▶ **CAUTION** indicates a possibly dangerous situation that can lead to light injury if not avoided.



▶ **ATTENTION** refers to a situation that may lead to material damage if not avoided.



## ▶ PRODUCT DESCRIPTION / AREA OF APPLICATION

▶ ALUTEC is a mounting solution for PV modules in a range of different installation situations. It is suitable for practically all framed PV modules with frame heights between 31 and 50 mm and for certain frameless modules. These installation instructions describe the installation of framed modules in a cross-bracing system on a pitched roof with pan tile cladding.

▶ Use only roof fastenings suitable for the respective roof structure and roof cladding. For example, the roof hooks must not press on the roof tiles or cause leaks by raising the roof tiles.

▶ The roof hooks described are not suitable for fastening to roofs with over rafter insulation.

▶ The roof substructure must be checked on site to ensure that it provides an adequate load-bearing reserve. Depending on the shape and pitch of the roof, wind suction loads  $> 2,400$  Pa (as per DIN EN 19911-4) can occur on the roof edges and corners in regions with high wind loads and most PV modules are not certified for this. Check this information for every project and, if in doubt, do not install on the roof edges and corner regions.









## ▶ CORRECT EDITION OF THE INSTALLATION INSTRUCTIONS

▶ The mounting systems from Creotecc GmbH are continuously improved and optimised. Therefore installation procedures can change at short notice. Please compare the printed installation instructions with the currently valid instructions available on our website at [www.creotecc.com](http://www.creotecc.com). If you do not have access to the internet, we would be happy to send you an up-to-date printed copy of the instructions upon request. If you encounter any difficulties during the installation process please do not hesitate to contact us.





© by Creotecc GmbH

# 4. MATERIAL & TOOL REQUIREMENTS

## MATERIAL – SYSTEM COMPONENTS

ITEM	ITEM NAME + NUMBER	DESCRIPTION
1	 HSA 533 NUS 030222	HSA 533 cast aluminium roof hook set with slot bolt
2	 ASSY 3.0SK 8x100 040081	Self-tapping woodscrew, washer head, Torx AW drive
3	 RL ALUVER Standard 020000	Mounting rail 30x50, length 6000
4	 AVS PC1-Set 020050	Connector set for RL AluVer Standard
5	 HC1-NUS 040314	ALUTEC retaining clip, pre-mounted with slot bolt
6	 RL ALUTEC 35 020027	Insertion rail, 35 mm frame, length 6000
7	 PC1-Set 020051	Connector set for RL ALUTEC
8	 RA6-Set 040121	Edge stop set for RL ALUTEC

## MATERIAL – OPTIONAL COMPONENTS



ITEM	ITEM NAME + NUMBER	DESCRIPTION
9	 RL ALUTEC BP 020006	Support rail, framed modules, length 6000 mm
10	 KC1 040029	Cable-tie clip for 1-3 mm flange
11	 KC2 040030	Cable-tie clip for 3-6 mm flange
12	 KS3 AV 4x 040497	Cable collector for RL ALUVER, up to 4 cables
13	 RUT AT 040038	EPDM T-piece for securing framed modules



# 4. MATERIAL & TOOL REQUIREMENTS



## MATERIAL – OPTIONAL COMPONENTS

ITEM	ITEM NAME + NUMBER	DESCRIPTION
14	 TOP AV Standard 040024	End cap for RL AluVer Standard
15	 ULP 2 040094	HDPE underlay plate for roof hook, blue, 2 mm
16	 ULP 5 040096	HDPE underlay plate for roof hook, grey, 5 mm

09

## TOOL REQUIREMENTS

ITEM	ITEM NAME + NUMBER	DESCRIPTION
A	 Bit-8 F 040136	8 bit for hexagonal head, with spring circlips
B	 MLG-Set 1300-1700 100045	Mounting jig set, big
C	 On-site	TORX 30 bit
D	 On-site	Allen key
E	 On-site	Steel square
F	 On-site	Tape measure
G	 On-site	Folding ruler
H	 On-site	Angle grinder
I	 On-site	Electric screwdriver



## 5. SYSTEM OVERVIEW

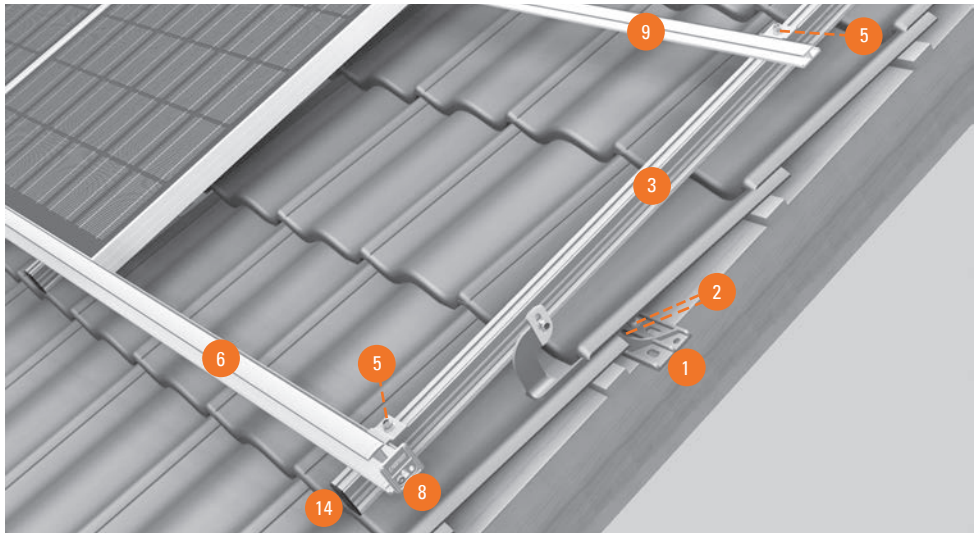

10

<p>1 HSA 533 NUS</p> 	<p>6 RL ALUTEC 35</p> 	<p>11 KC2</p> 
<p>2 ASSY 3.0SK 8x100</p> 	<p>7 PC1-Set</p> 	<p>12 KS3 AV 4x</p> 
<p>3 RL ALUVER Standard</p> 	<p>8 RA6-Set</p> 	<p>13 RUT AT</p> 
<p>4 AVS PC1-Set</p> 	<p>9 RL ALUTEC BP</p> 	<p>14 TOP AV Standard</p> 
<p>5 HC1-NUS</p> 	<p>10 KC1</p> 	<p>15 ULP 2 oder 16 ULP 5</p> 

# 6. INSTALLATION OF ALUTEC



## FASTENING DENSITY OF HSA 533 ROOF HOOKS

required number of roof hooks per m<sup>2</sup> of module area for different loading conditions

ROOF PITCH	WIND- PRESSURE q*	SNOW LOAD s <sub>k</sub> ** IN kN/m <sup>2</sup>			
		0,65	0,85	1,00	1,75
Degrees  20°	kN/m <sup>2</sup>				
	0,50	0,65	0,78	0,88	1,41
	0,80	0,74	0,81	0,92	1,44
	0,95	0,89	0,89	0,93	1,46
	1,25	1,19	1,19	1,19	1,49
30°	0,50	0,69	0,83	0,93	1,46
	0,80	0,77	0,88	0,98	1,51
	0,95	0,92	0,92	1,00	1,53
	1,25	1,22	1,22	1,22	1,58
40°	0,50	0,55	0,64	0,70	1,03
	0,80	0,80	0,80	0,80	1,10
	0,95	0,95	0,95	0,95	1,13
	1,25	1,25	1,25	1,25	1,25

\*) Gust speed pressure

\*\*) Characteristic value of snow load on the ground

This table is for orientation purposes only. It does not replace proper structural planning! Higher wind loads in the edge regions of the roof and the system are not taken into account in this table.



## 6. INSTALLATION OF ALUTEC

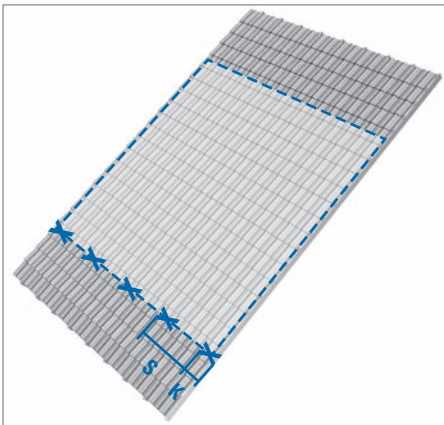
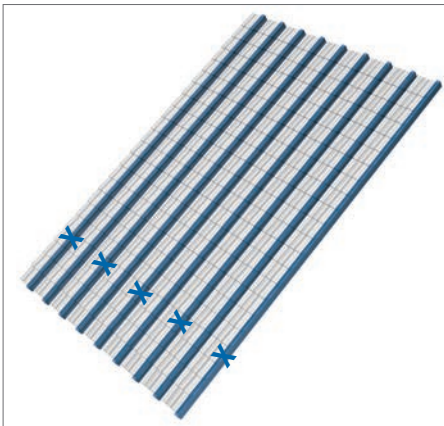
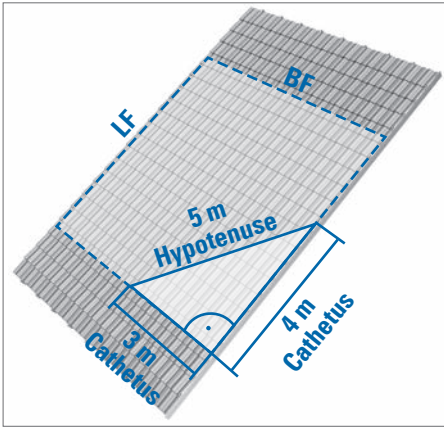

### MEASURING THE ROOF

- ▶ Mark the areas on the roof that will be covered by each continuous module array (including the ALUTEC insertion rails (item 6)).
- ▶ Calculate the length and width of the field using the formulae  
 $LF = (\text{module length} + 12) \times \text{number of modules} + 56$ ;  
 $BF = (\text{module width} + 5) \times \text{number of modules} - 5$ .  
[all dimensions in mm.]
- ▶ **TIP:** You can measure an accurate right-angle using a sample right-angled triangle with sides of length 3-4-5.
- ▶ Select the rafters on which the roof hooks (item 1) will later be installed.
- ▶ Mark the position of the selected rafters at the lower edge of the system.
- ▶ Ensure that the span  $S$  and edge cantilever length  $C$  of the ALUTEC insertion rails (item 6) do not exceed the maximum specifications.

## 6. INSTALLATION OF ALUTEC

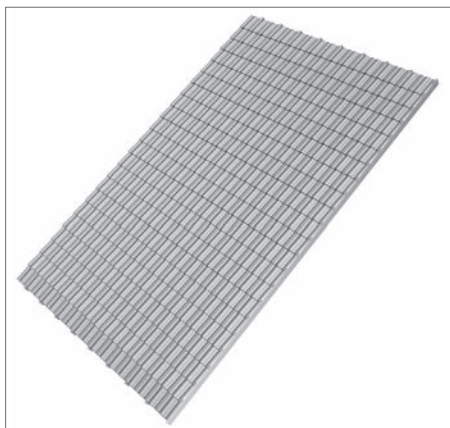
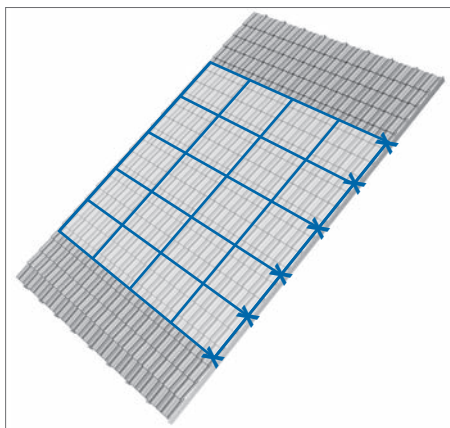
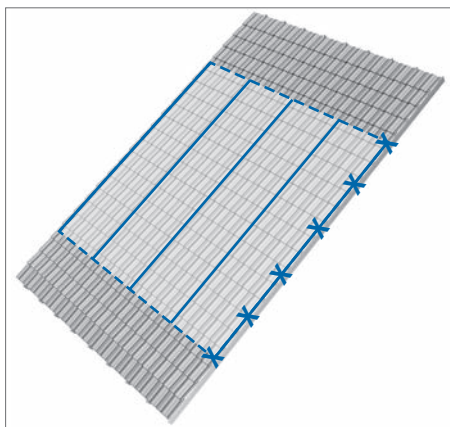

- ▶ Select the row of tiles in which the roof hooks will later be installed.
- ▶ Mark the position of the selected tiles at the side edge of the system and across the entire area of the system starting from this position.
- ▶ Ensure that the span  $S$  and edge clearance  $K$  of the ALUVER mounting rails (item 3) do not exceed the maximum specifications.
- ▶ Mark all tiles in the entire area of the system under which the roof hooks will be mounted later.
- ▶ Ensure that the minimum fastening density for the roof hooks is adhered to.



## 6. INSTALLATION OF ALUTEC

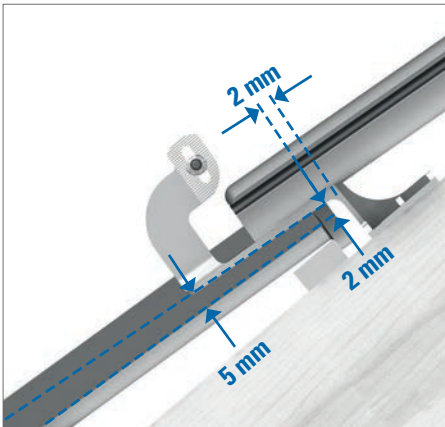
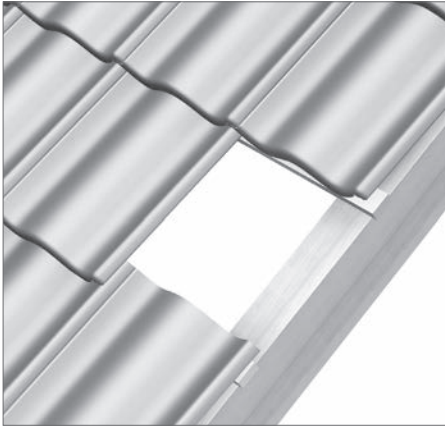

### ▶ ADJUSTING THE ROOF HOOKS

- ▶ Remove the marked tiles; it may also be necessary to lift, slide or remove adjacent tiles.
- ▶ If necessary, mark the part of the interlocking joint under the tile that needs to be removed so that the roof hooks can pass between this tile and the tile underneath.
- ▶ If necessary, remove the interlocking joint at the marked position on the removed tile using an angle grinder (with clay tiles, an expert roofer can use a hammer for this). Remove only the amount of material that is absolutely necessary, work only on the interlocking joint and avoid weakening or damaging of the tile.

**⚠ ATTENTION** Work with gloves, protective clothing and protective goggles. Avoid damage caused by flying tile fragments and sparks.

- ▶ Adjust the roof hooks (item 1) correctly. Make sure that the hook sits in the „trough“ of the tile underneath, that the mounting bracket has a clearance of at least 2 mm from the upper edge of the tile (vertically and horizontally) and that the lower end of the retaining clamp has a clearance of at least 5 mm from the tile underneath.

**⚠ ATTENTION** An incorrectly adjusted roof hook can damage the tile underneath, even under normal loading deformation.

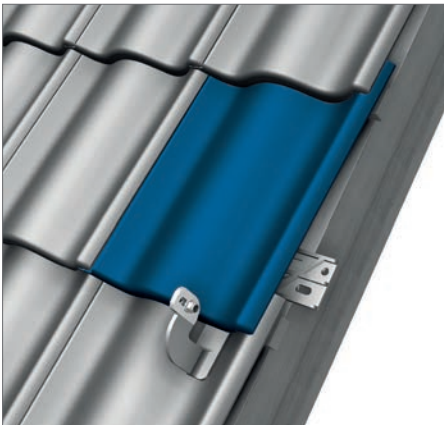

## INSTALLING THE ROOF HOOKS

- ▶ If necessary, use underlay plates (items 15 and 16) to ensure adequate clearance between the roof hook and the tile underneath.
- ▶ If necessary, use HSA 582 (030305) 3-way adjustable roof hooks that allow continuous vertical and horizontal adjustment.
- ▶ Take care to ensure the minimum edge clearance in the wood and adequate sideways offset between the two screws.
- ▶ Fasten the roof hooks to the rafters using two self-drilling wood screws (item 2).

**⚠ ATTENTION** If counterbattens that cannot be used for anchoring are mounted on the rafters then the length of the screws chosen must be increased by the thickness of the counter battens.

**⚠ ATTENTION** **Minimum screwing depth in supporting wood: 70 mm.**

**⚠ ATTENTION** Make sure that the screws and hook are securely installed but do not use an impact screwdriver for installation.

- ▶ Replace the removed tile(s) and restore all other tiles to their correct position. After this, check to make sure that no tile is clamped (danger of breakage) or sits too high (danger of leakage).

**⚠ ATTENTION** The roof hooks are not approved for use as a climbing aid or a safety attachment point.





## 6. INSTALLATION OF ALUTEC

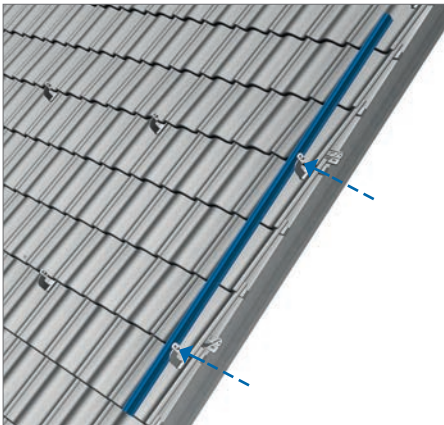
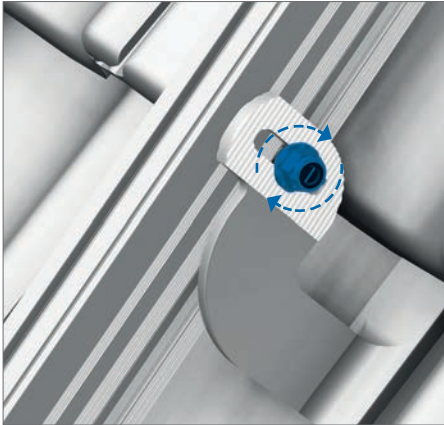
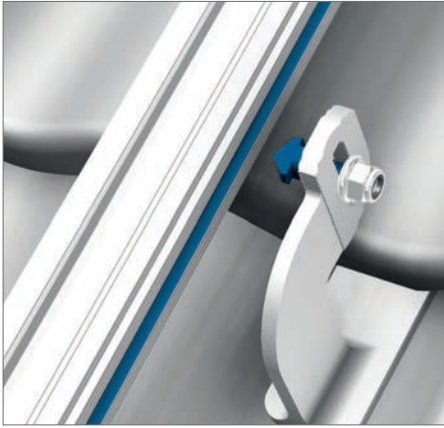

### ▶ MOUNTING THE VERTICAL RAILS

- ▶ Position the ALUVER rail (item 3) on the elongated hole in the roof hook so that the slot bolt fits into the slot in the rail (rotate the screw if necessary) and the corrugations on the roof hook and rail grip each other.

- ▶ **TIP:** Compensate for irregularities in the roof by fitting the rail higher or lower in the elongated hole.

- ▶ Fasten the connection by tightening the nut (**torque of 25 Nm**). Make sure that the screw head is first rotated by 90° so that it is anchored in the slot.

**⚠ ATTENTION** If the screw is not fully rotated, i.e. by a full 90°, then a secure screwed connection is not ensured.

- ▶ Screw each rail (item 3) to each of the corresponding roof hooks (item 1) in the same manner. Use the height adjustment feature to avoid any tensioning of the rails and roof hooks.

**⚠ ATTENTION** The screwed connection to the roof hooks must not occur at the outermost ends of the rail. Make sure that the end of the rail always protrudes beyond the fastening flange of the roof hook.



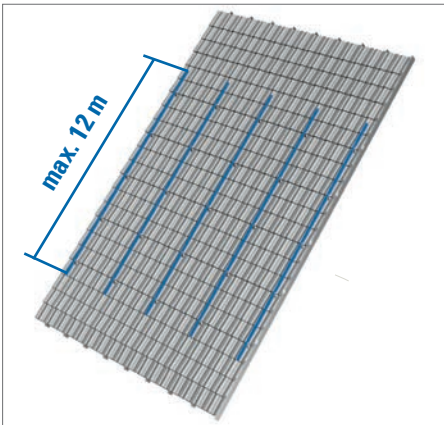
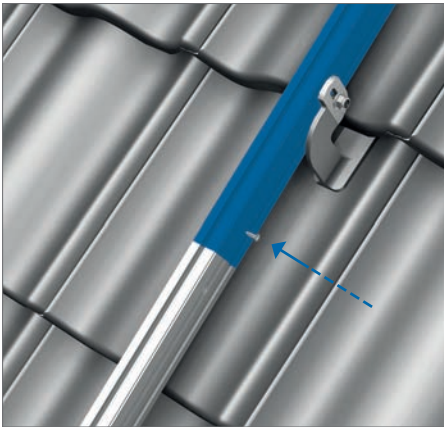
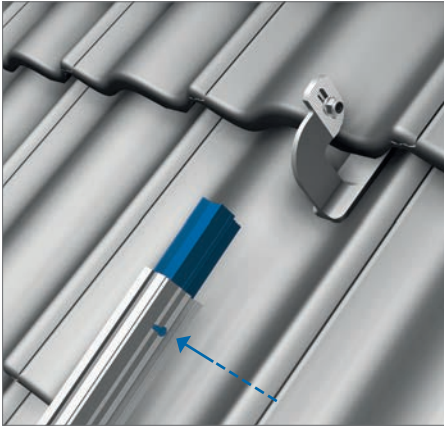

## CONNECTING THE HORIZONTAL RAILS

Slide the connector (item 4) halfway into one of the rails to be joined and fasten it in position using a self-drilling screw. Position the self-drilling screw in the side drill groove of the rail when doing this so that the screw can easily penetrate the connector.

Slide the other rail (item 3) fully onto the connector (item 4) so that no gap remains between the rail segments. Fasten the second rail to the connector as described above.

**NOTE:** The connection is rigid and does not function as an expansion joint.

Connect all rails (item 3) in the manner described.

**⚠ ATTENTION** Do not create rigidly connected rails to a length greater than 12 m to avoid damage caused by heat expansion of the aluminium. After 12 m, create either a maintenance gap or fasten the connector only on one side to create an expansion gap; note that in the latter case no module may then be mounted over this expansion gap.



## 6. INSTALLATION OF ALUTEC

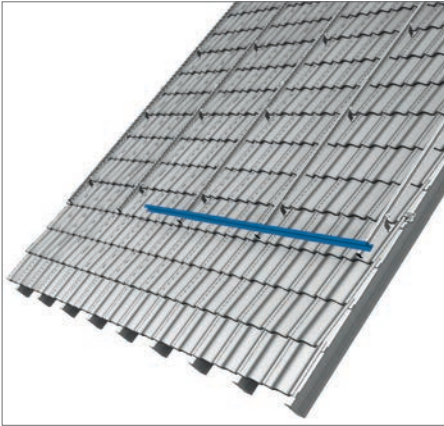

### ▶ MOUNTING THE HORIZONTAL RAILS

- ▶ Start at the lower end of the module array.
- ▶ Place the ALUTEC insertion rail (item 6) horizontally on the ALUVER mounting rail (item 3).
- ▶ Ensure that the entire width of the lowest ALUTEC rail lies correctly on the ALUVER rail.

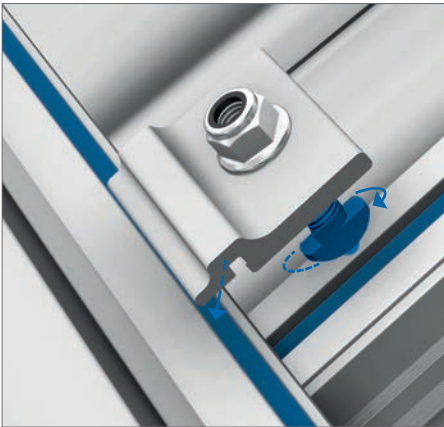

- ▶ Fit the pre-assembled retaining clips (item 5) to the upper fastening flange of the ALUTEC rails. When the head of the slot screw lies in the slot, turn the nut 90° clockwise to lock the head of the screw and then tighten the nut to a **torque of 25 Nm**.

**⚠ ATTENTION** Make sure that the head of the slot screw is in the „locked“ position before tightening the nut.



- ▶ When finished, check that the ALUTEC rails run straight and level and that they are at right angles to the ALUVER rails.
- ▶ **TIP:** Subsequent corrections are then more difficult to perform than at this point in the installation process.

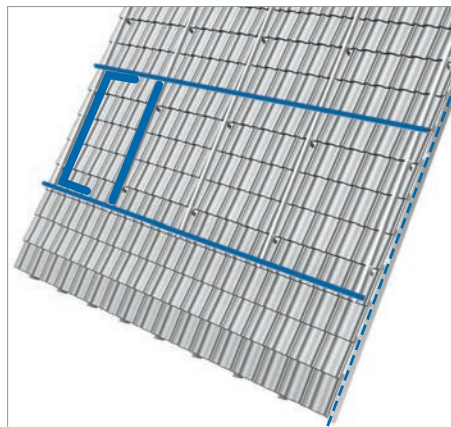
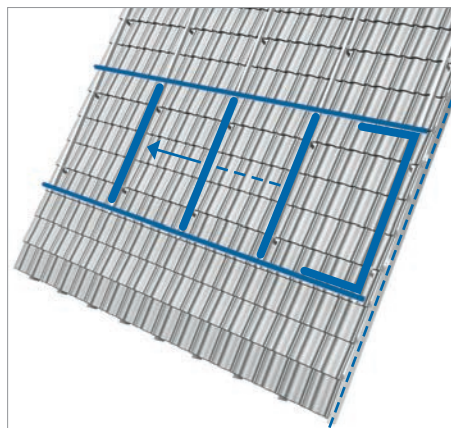
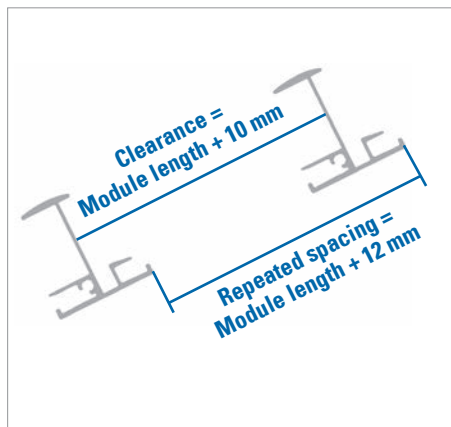

## ▶ MOUNTING THE UPPER INSERTION RAIL

- ▶ Use the assembling jig (item B) to position the upper of the two ALUTEC insertion rails (item 6) so that a gap exists between the two rails having a clearance  $W$  of

$$W = \text{module length (in mm)} + 10 \text{ mm.}$$

- ▶ **NOTE:** You can also work with the repeated spacing dimension  $S$  and mark the position of the upper rail or the upper retaining clip (item 5), where

$$S = \text{module length (in mm)} + 12 \text{ mm.}$$

- ▶ Position the U-shaped gauge (set to clearance  $W$ ) between the ends of the ALUTEC insertion rails (item 6) to check the flush alignment of the rails, in addition to the clearance and parallel alignment of the rails.

- ▶ Use the rod gauge (also set to  $W$ ) in the region of the second vertical rails between the horizontal rails (item 3) to ensure that the frame elements are parallel.

- ▶ Fasten the upper ALUTEC insertion rail with the retaining clips (item 5).

- ▶ Then use the rod gauge between all other vertical rails (item 6) at the height of the horizontal rails (item 3) to ensure that the frame elements are parallel.

- ▶ Fasten each of the upper ALUTEC insertion rails with the retaining clips (item 5).

- ▶ Use the U-shaped gauge at opposing ends of the rails to check the flush alignment of the rails.



## 6. INSTALLATION OF ALUTEC

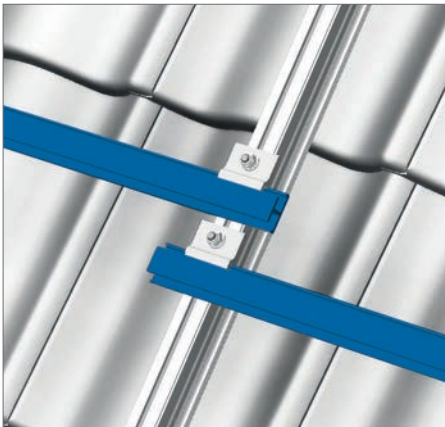
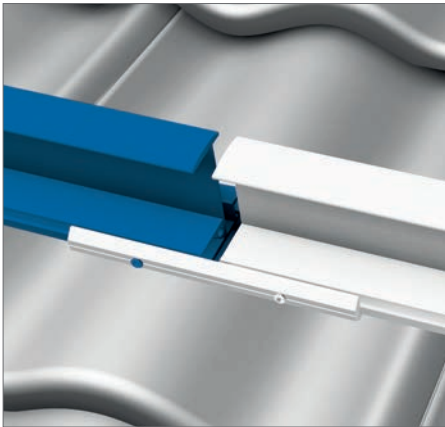
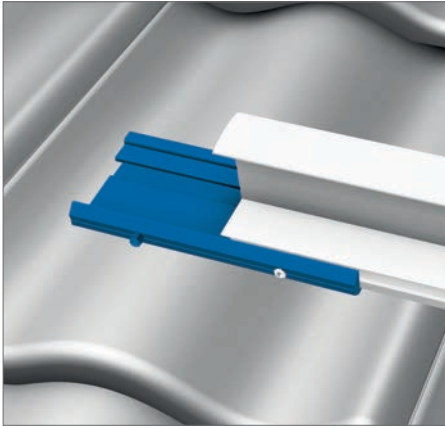

### ▶ EXTENDING THE ALUTEC RAILS

**⚠ ATTENTION** The ALUTEC connector (item 7) cannot be fitted to the ALUVER rail (item 3) at the intersection point. If this occurs then the rail trimming must be changed or the arrangement of the rails must be changed.

- ▶ Plug the ALUTEC connector (item 7) halfway onto the end of the rail.
- ▶ Firmly tighten the grub screw on this side.
- ▶ Insert the next rail into the connector, leaving a gap of 10 mm between the rails. Tighten the grub screw on this side tightly enough so that there is no free play in the connector but the connector is not prevented from moving under heat expansion.
- ▶ Fasten the connected rail using retaining clips as described previously. Check that the rail is straight and has the correct clearance as described previously.

### ▶ INSTALLING SUPPORT RAILS

- ▶ **NOTE:** When mounting modules vertically in areas subject to high snow and/or wind loads it may be necessary to support the middle of the module. To do this, fit the ALUTEC support rail (item 9) at the halfway height between the ALUTEC insertion rails and parallel to these. As with the insertion rails, the support rail is also fastened to the vertical ALUVER mounting rails (item 3) using HC1-NuS retaining clips (item 5). 3 fastening points per 6 m section are sufficient. Allow the ends of the rails to overlap at the first and last support points.



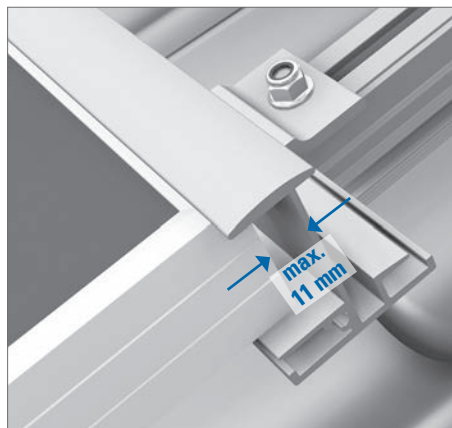
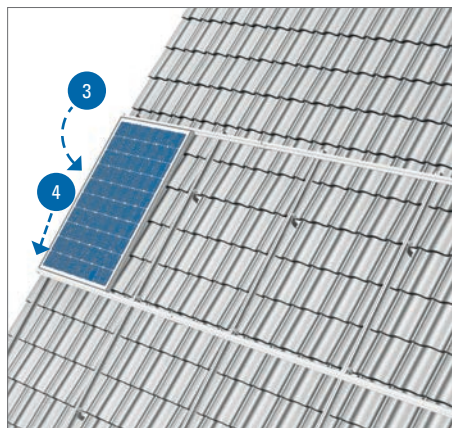
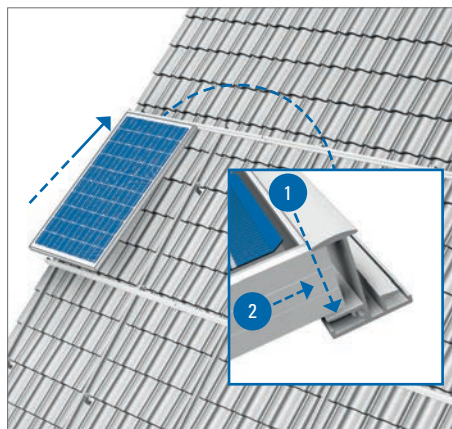

## ▶ INSERTING THE MODULES

▶ Position the first module on the uppermost ALUTEC rail (item 6) **1**.

▶ Slide the module all the way up **2**.

▶ Position the module on the lower ALUTEC rail **3**.

▶ Allow the module to slide down **4**.

**⚠ ATTENTION** A gap of 9-11 mm should remain at the upper edge of the module frame. If the gap is wider than this then the position of the ALUTEC rail must be corrected



## 6. INSTALLATION OF ALUTEC

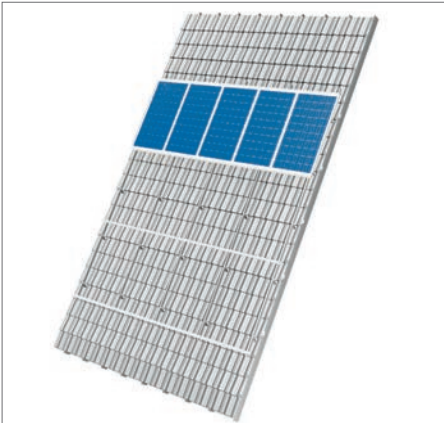
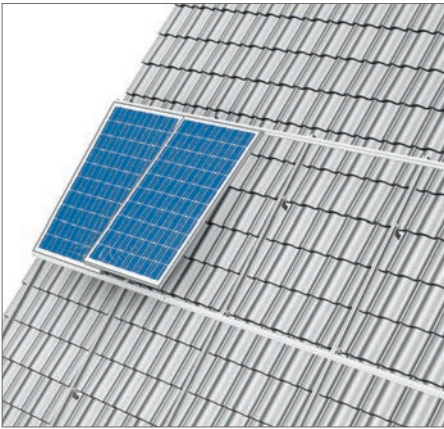
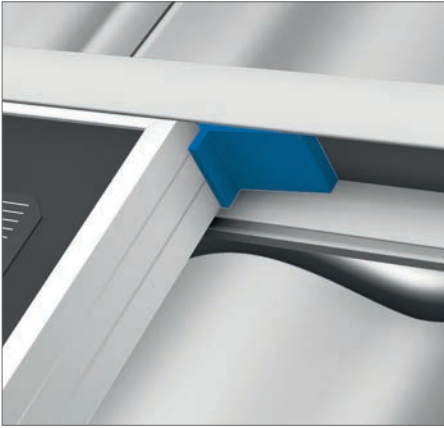

▶ **NOTE:** The T-piece for securing the modules is only installed when the module inclination is less than  $10^\circ$  (obligatory) or when the modules are to be secured against theft (optional).

▶ In this case, mount a T-piece (item 13) next to the module in the upper ALUTEC rail (item 6).

▶ Fit the next module next to the first module (flush with the T-piece if necessary).

▶ Leave a clearance of at least 3 mm between the modules.

▶ Continue in the same way with all other modules.



### FASTENING THE CABLE CLIP

- ▶ If required, plug a cable tie clip (item 10) into the module frame of each module and feed the module cable through this for fastening the module cables.
- ▶ Lay the free cable to the respective cable clip of the adjacent module and plug this into the cable fastened to this module.



- ▶ If required, plug cable tie clips (item 11) into the fastening pads of the ALUTEC rails (item 6) for fastening the module cables and string cables.

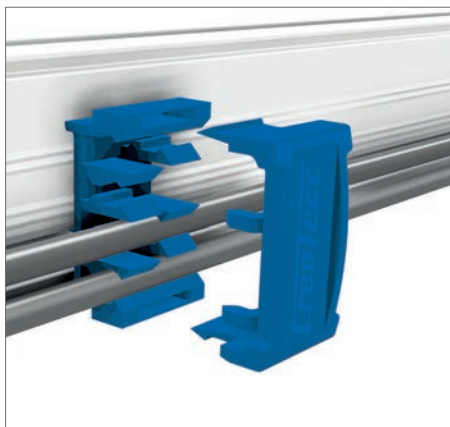

### FASTENING THE CABLE COLLECTOR

- ▶ If required, insert cable collectors (item 12) into the side slot of the ALUVER rails (item 3) for fastening the module cables and string cables.



## 6. INSTALLATION OF ALUTEC

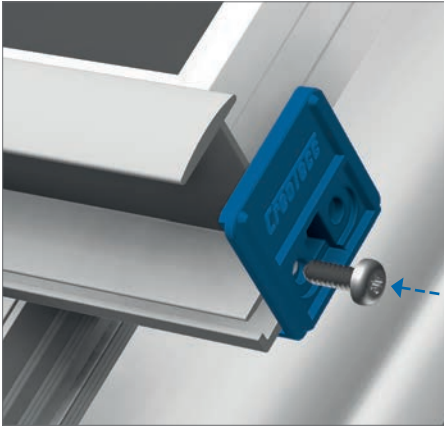

### ▶ MOUNTING THE END STOPS

- ▶ Fasten an end stop (item 8) to the end of each ALUTEC rail. Fit the end stop so that the large opening leaves the the drainage channel of the rail free. Screw the self-tapping screw (item 8) into the screw channel of the rail as far as it will go.

- ▶ **NOTE:** In conjunction with the module securing fitting (item 13) the end stop provides protection against module theft when it is fastened with a safety screw (available from Creotecc).

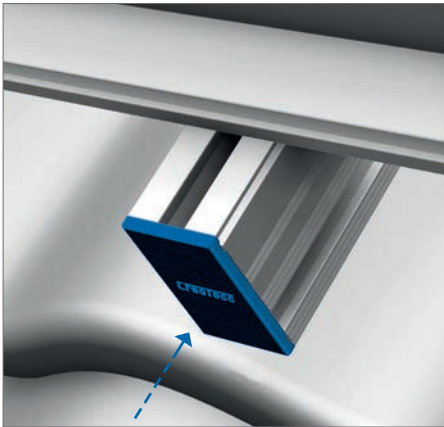

### ▶ MOUNTING THE COVER CAPS

- ▶ Optionally close off the upper and lower ends of the ALUVER rail sections (item 3) with cover caps (item 14).

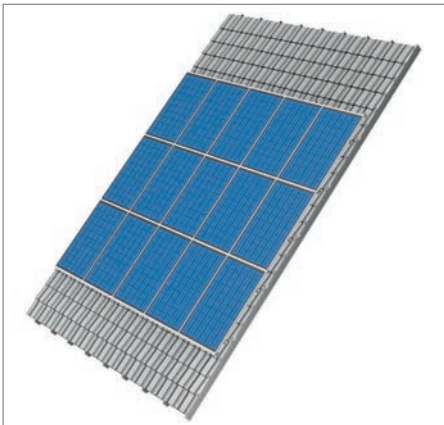

- ▶ Finished installation.



## 6. INSTALLATION OF ALUTECH

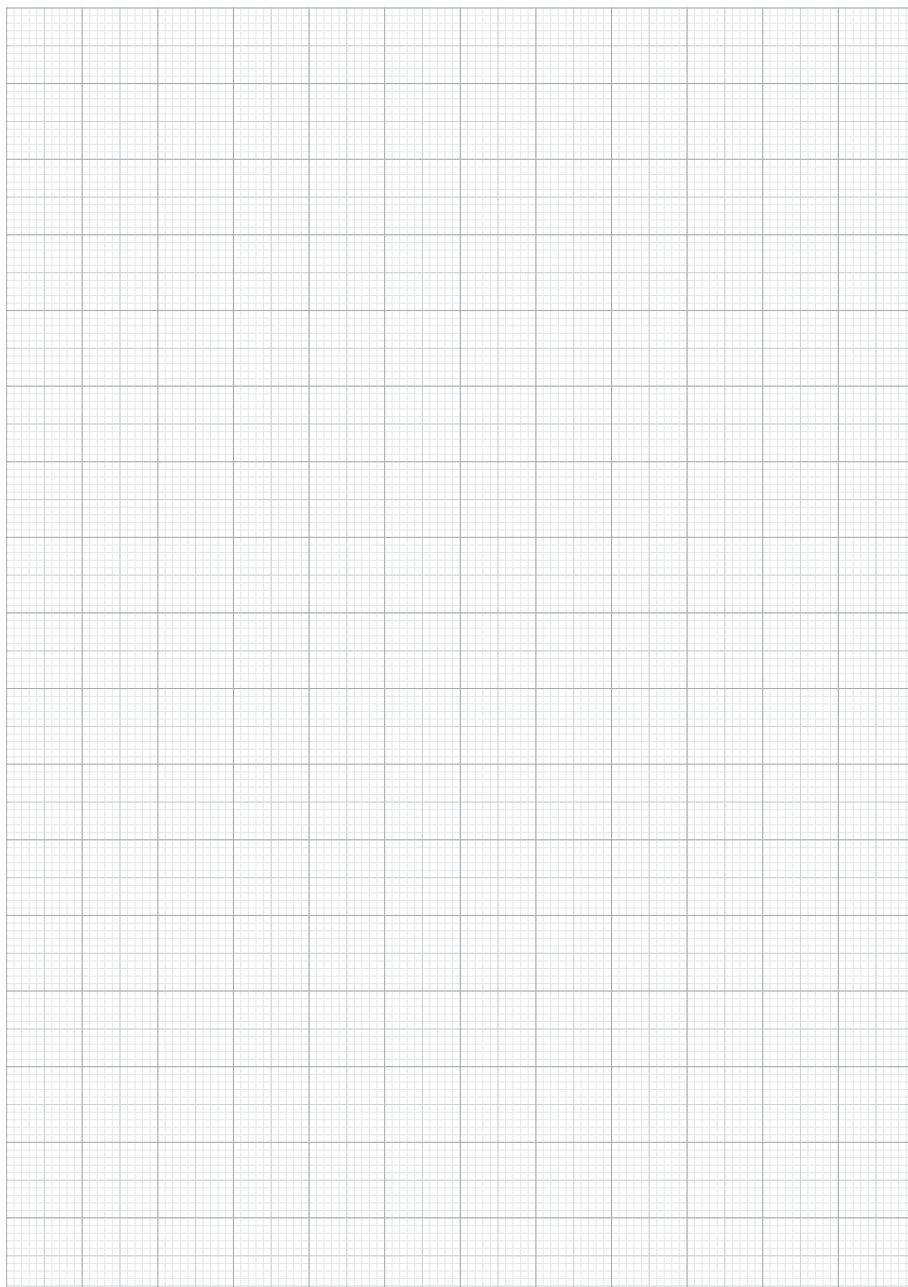



## 6. INSTALLATION OF ALUTEC

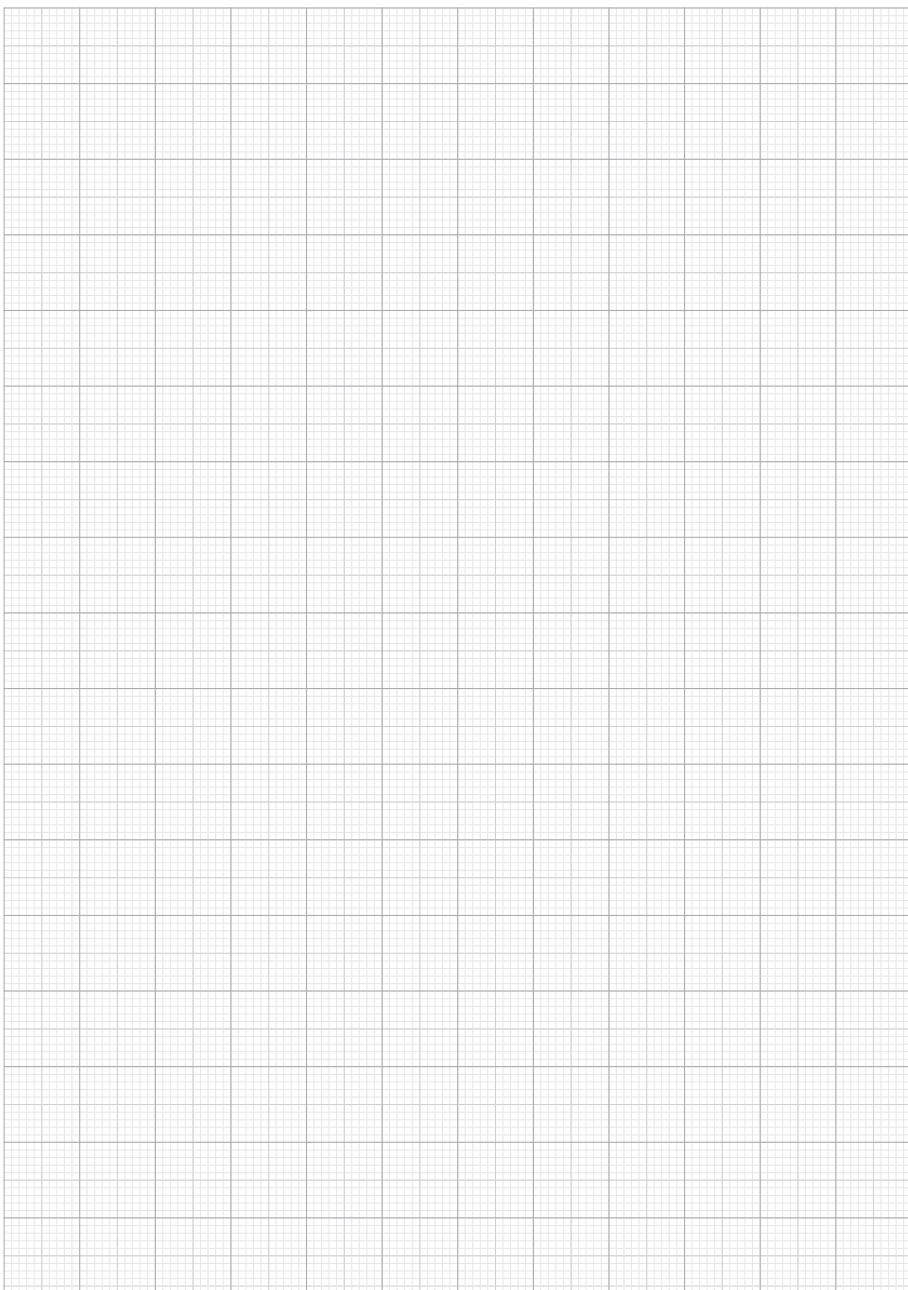



## ▶ MAINTENANCE

- ▶ The following maintenance requirements must be adhered to:
  - ▶ Have the photovoltaic system checked annually by a specialist photovoltaic company to confirm the full functionality and mechanical stability of the system. In addition to a visual inspection of the mounting system, especially the tightness of the screwed connections and the watertightness of the roof cladding are to be checked.
  - ▶ The safety instructions and all other specifications in these installation instructions must be adhered to for all work on the mounting system and the DC cabling. The installation instructions also apply in principle to any removal work, in the reverse sequence where applicable.
  - ▶ Especially the DC electrical connections must never be disconnected while under load (danger of arcing) and the current must always first be switched off via the circuit breaker in or on the generator junction box or inverter.

# CREOTECC

**CREOTECC GMBH**

Bebelstraße 6 | 79108 Freiburg, Germany  
Tel.: +49 761 21686-0 | Fax: +49 761 21686-29  
info@creotecc.com | www.creotecc.com