

**NOMAD<sup>®</sup> 200**

---

SOLAR PANEL

---

**USER GUIDE**

 | GOALZERO<sup>®</sup>

## GET TO KNOW YOUR GEAR

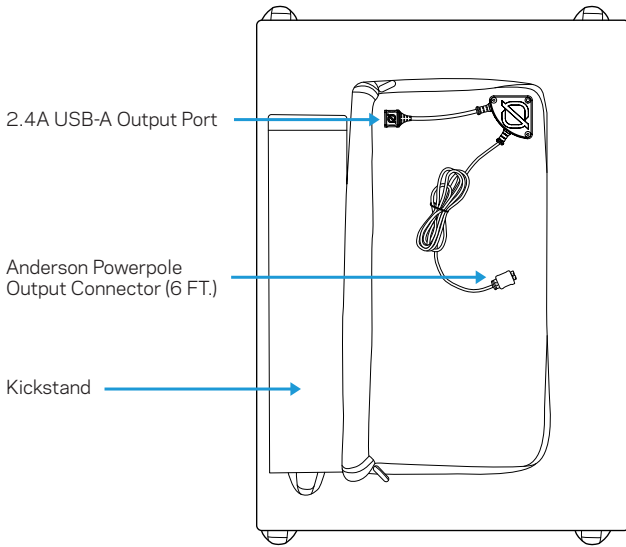

## HOW TO CONNECT

Plug the APP connector into the input port on the Goal Zero Yeti. You'll get the best solar charging experience if you continue to reposition the solar panel throughout the day. Make sure to reference the specs of what you're plugging the Nomad 200 into. On Yeti Portable Power Stations, you'll be checking the input specs.

### HOW IT WORKS

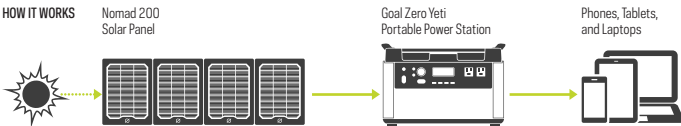

## HOW TO CHAIN

To chain multiple Nomad 200 Solar Panels together, you'll need to purchase the 4x Anderson Combiner Cable (SKU 98061) from Goal Zero.

## TECHNICAL SPECIFICATIONS

### Charge Times

Goal Zero Yeti 1000X	6-12 hrs
Goal Zero Yeti 1500X	9-18 hrs
Goal Zero Yeti 3000X	18-36 hrs

### Solar Panel

Rated Power	200W
Open Circuit Voltage Voc	23.0V
Cell Type	Monocrystalline

### Ports

Anderson Powerpole	14-23V, up to 14A (200W max)
USB-A (output)	5V, 2.4A(12W max)

### General

Weight	22 lbs (10.0 kg)
Dimensions (unfolded)	28.2 x 100.7 x 1.0 in (71.6 x 255.8 x 2.5 cm)
Dimensions (folded)	28.2 x 22.3 x 2.0 in (71.6 x 56.6 x 5.0 cm)
Certs	
Warranty	12 months

Be sure to activate your warranty at [goalzero.com/warranty](https://www.goalzero.com/warranty)

## APPRENEZ À CONNAÎTRE VOTRE ÉQUIPEMENT

Port de sortie 2,4 A  
USB-A

Anderson Power Pole  
Connecteur de sortie (2 m)

Béquille

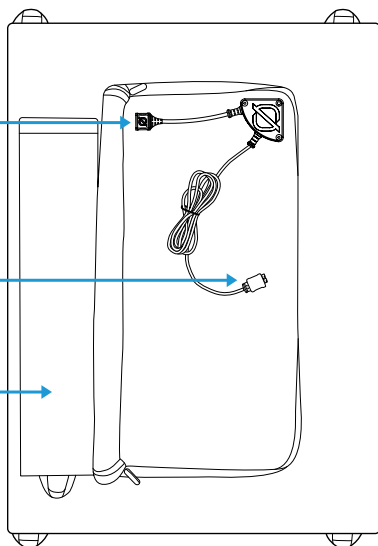

## COMMENT LE CONNECTER

Branchez le connecteur APP dans le port d'entrée du Goal Zero Yeti. Vous obtiendrez la meilleure expérience de charge solaire qui soit en réorientant le panneau solaire tout au long de la journée. Assurez-vous de faire référence aux spécifications de ce que vous connectez à votre Nomad 200. Pour les alimentations portatives Yeti Portable Power Stations, vous devrez vérifier les spécifications d'entrée.

COMMENT ÇA  
FONCTIONNE

Nomad 200  
Panneau Solaire

Goal Zero Yeti  
Alimentation Portative

Téléphones, Tablettes,  
et Ordinateurs  
portables



## COMMENT CONNECTER EN SÉRIE

Pour connecter plusieurs panneaux solaires Nomad 200 en série, vous devrez acheter le câble combineur 4x Anderson Combiner Cable (SKU 98061) vendu par Goal Zero.

## SPÉCIFICATIONS TECHNIQUES

### Temps de charge

Goal Zero Yeti 1000X	6-12 hrs
Goal Zero Yeti 1500X	9-18 hrs
Goal Zero Yeti 3000X	18-36 hrs



### Panneau Solaire

Puissance nominale	200 W
Tension en circuit ouvert (V <sub>co</sub> )	23.0V
Type de batterie	Monocristalline

### Ports

Anderson Power Pole	14-23 V, jusqu'à 14 A (200 W max)
USB-A (sortie)	5 V, 2,4 A (12 W max)

### Général

Poids	10,0 kg (22 lb)
Dimensions (déplié)	71,6 x 255,8 x 2,5 cm (28,2 x 100,7 x 1,0 in)
Dimensions (plié)	71,6 x 56,6 x 5,0 cm (28,2 x 22,3 x 2,0 in)
Certifications	  
Garantie	12 mois

N'oubliez pas d'activer votre garantie sur [goalzero.com/warranty](https://goalzero.com/warranty)

## LERNE DEIN GERÄT KENNEN

2,4 A USB-A-Ausgang

Anderson Powerpole  
Ausgangsanschluss (6 FT.)

Kickstand

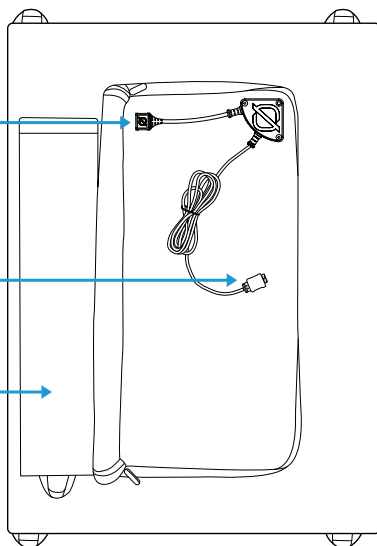

## VERBINDE DEIN GERÄT

Stecken Sie den APP-Stecker in den Eingangsanschluss des Goal Zero Yeti. Die beste Solaraufladung findet statt, wenn Sie das Solarpanel während des Tages immer wieder neu platzieren. Überprüfe unbedingt die Spezifikationen der Anschlüsse, an die du das Nomad 200 ansteckst. An den Yeti Tragbaren Stromversorgungen können Sie die Eingangsspezifikationen prüfen.

SO FUNKTIONIERT'S

Nomad 200  
Solarmodul

Goal Zero Yeti  
Tragbare Power Station

Telefone, Tablets,  
Laptops

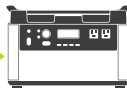
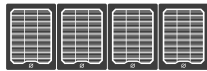

## VERKETTE DEIN GERÄT

Um mehrere Nomad 200 Solarmodule miteinander zu verketten ist der Kauf eines 4x Anderson-Kombinationskabels (SKU 98061) von Goal Zero notwendig.

## TECHNISCHE SPEZIFIKATIONEN

### Ladezeiten

Goal Zero Yeti 1000X	6-12 Std.
Goal Zero Yeti 1500X	9-18 Std.
Goal Zero Yeti 3000X	18-36 Std.



### Solarmodul

Nennleistung	200 W
Leerlaufspannung (Voc)	23.0V
Akkutyp	Monokristallin

### Anschlüsse

Anderson Powerpole	14 - 23 V, bis zu 14 A (max. 200 W)
USB-A (Ausgang)	5 V, 2,4 A(12 W max.)

### Allgemein

Gewicht	10,0 kg
Abmessungen (auseinandergeklappt):	71,6 x 255,8 x 2,5 cm
Abmessungen (zusammengeklappt):	71,6 x 56,6 x 5,0 cm
Zertifikate	 
Garantie	12 Monate

Denke daran, deine Garantie zu aktivieren: [goalzero.com/warranty](https://goalzero.com/warranty)

## CONOZCA SU EQUIPO

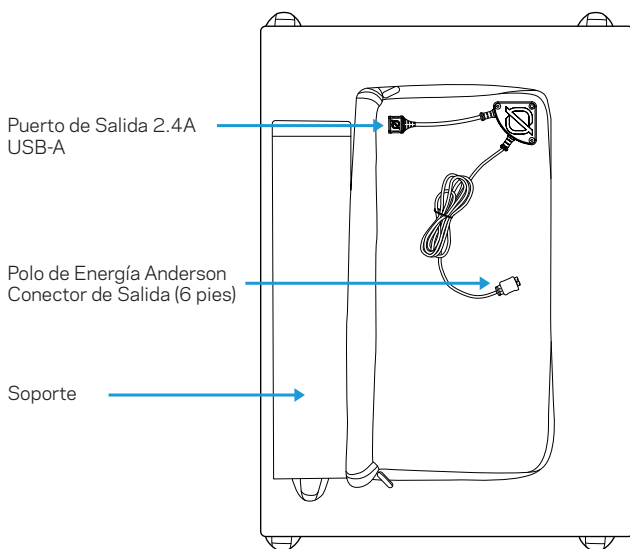

## COMO CONECTAR

Enchufe el conector de la aplicación en el puerto de entrada del Goal Zero Yeti. Obtendrá la mejor experiencia de carga solar si continúa repositonando el panel solar durante todo el día. Asegúrese de hacer referencia a las especificaciones de lo que está conectando al Nomad 200. En las estaciones de energía portátil Yeti, debe verificar las especificaciones de entrada.

### CÓMO FUNCIONA

Nomad 200  
Nomad 28 Plus

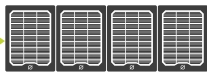

Goal Zero Yeti  
Estación de Energía Portátil

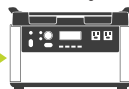

Teléfonos, tabletas  
y ordenadores  
portátiles





## COMO CONECTAR EN SERIE

Para encadenar múltiples paneles solares Nomad 200, deberá comprar el 4x Anderson Combiner Cable (SKU 98061) de Goal Zero.

## ESPECIFICACIONES TÉCNICAS

### Tiempos de Carga

Goal Zero Yeti 1000X	6-12 horas
Goal Zero Yeti 1500X	9-18 horas
Goal Zero Yeti 3000X	18-36 horas

### Nomad 28 Plus

Potencia nominal	200W
Voc, voltaje en circuito abierto	23.0V
Tipo de Celda	Monocristalino

### Entradas

Polo de Energía Anderson	14-23V, hasta 14A (200W máx)
USB-A (salida)	5V, 2.4A(12W máx)

### General

Peso	22 lbs (10,0 kg)
Dimensiones (desplegado)	28,2 x 100,7 x 1,0 pulg (71,6 x 255,8 x 2,5 cm)
Dimensiones (plegado)	28,2 x 22,3 x 2,0 pulg (71,6 x 56,6 x 5,0 cm)
Certificaciones	
Garantía	12 meses

Asegúrese de activar su garantía en [goalzero.com/warranty](https://www.goalzero.com/warranty)

## FAMILIARIZZA CON LA TUA ATTREZZATURA

Porta di uscita  
USB-A 2.4 A

Polo di energia elettrica  
Anderson  
Connettore uscita (6 piedi.)

Supporto estraibile

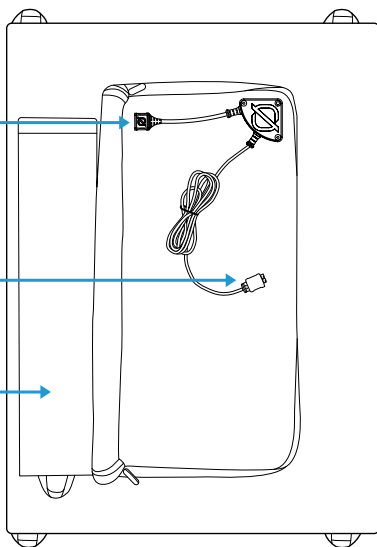

## COME COLLEGARLO

Inserire il connettore APP nella porta di entrata sulla Yeti Goal Zero. Si otterrà la migliore esperienza di ricarica solare se si continua a riposizionare il pannello solare nel corso della giornata. Assicurarsi di indirizzare le specifiche di ciò che si inserisce al bauletto Nomad 200. Sulle centrali elettriche portatili Yeti, si dovrà controllare le specifiche di entrata.

COME FUNZIONA

Nomad 200  
Pannello solare

Yeti Goal Zero  
Stazione elettrica portatile

Telefoni, tablet e  
portatili

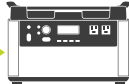
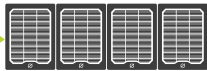

## COME CONCATENARE

Per concatenare i multipli pannelli solari Nomad 200 insieme, sarà necessario acquistare il cavo combinatorio 4x Anderson (SKU 98061) da Goal Zero.

## SPECIFICHE TECNICHE

### Tempi di carica

Yeti 1000X Goal Zero	6-12 ore
Yeti Goal Zero 1500X	9-18 ore
Yeti 3000X Goal Zero	18-36 ore

### Pannello solare

Potenza nominale	200W
Tensione circuito aperto <i>C<sub>ov</sub></i>	23.0V
Tipo cella	Monocristallina

### Porte

Polo di energia elettrica Anderson	14-23V, fino a 14A (200W massimo)
USB-A (uscita)	5V, 2.4A(12W max)

### Generale

Peso	22 libbre (10.0 kg)
Dimensioni (distese)	28.2 x 100.7 x 1.0 pollici (71.6 x 255.8 x 2.5 cm)
Dimensioni (distese)	28.2 x 22.3 x 2.0 pollici (71.6 x 56.6 x 5.0 cm)
Certificati	
Garanzia	12 mesi

Assicurarsi di attivare la garanzia su [goalzero.com/warranty](https://www.goalzero.com/warranty)

## あなたのギアを知りましょう

2.4A USB-A 出力ポート

アンダーソンパワーポール  
出力コネクタ (6 フィート)

キックスタンド

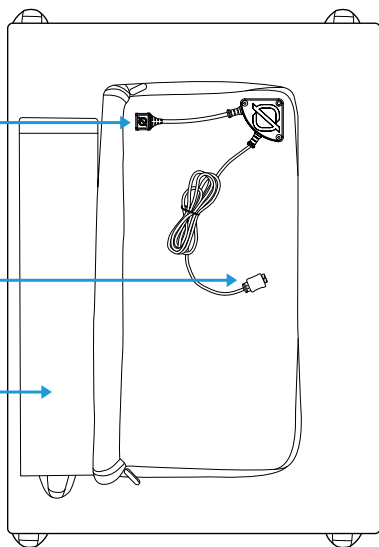

## 接続方法

APP コネクタを Goal Zero Yeti の入力ポートに接続します。1日を通してソーラーパネルの角度を太陽に向けて調整し続けると、最適な充電が行えます。Nomad 200 に接続する機器については、製品仕様を必ず参照してください。Yeti ポータブルパワーステーションで、入力仕様を確認します。

使用方法

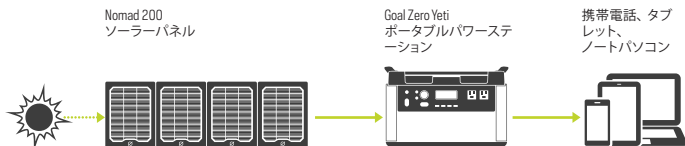

## チェーン接続の方法

複数の Nomad 200 ソーラーパネルを連結して使用するには、Goal Zero からアンダーソンソンプライナーケーブル (SKU 98061) を 4 本購入する必要があります。

## 技術仕様

### 充電時間

Goal Zero Yeti 1000X	6~12 時間
Goal Zero Yeti 1500X	9~18 時間
Goal Zero Yeti 3000X	18~36 時間

### ソーラーパネル

定格出力	200W
開回路電圧 Voc	23.0V
セルタイプ	単結晶

### ポート

アンダーソンパワーポール	14~23V、14A まで (最大 200W)
USB-A (出力)	5V、2.4A (最大 12W)

### 全般

重量	22 lbs (10.0 kg)
寸法 (使用時)	28.2 x 100.7 x 1.0 インチ (71.6 x 255.8 x 2.5 cm)
寸法 (収納時)	28.2 x 22.3 x 2.0 インチ (71.6 x 56.6 x 5.0 cm)
安全規格	

保証	12 ヶ月
----	-------

[goalzero.com/warranty](http://goalzero.com/warranty) にて製品保証を必ず有効にしてください

## GOAL ZERO HEADQUARTERS

675 West 14600 South  
Bluffdale, UT 84065  
1-888-794-6250  
Designed in the U.S.A.  
Made in China

Nomad is a trademark of Goal Zero.

This equipment has been tested and found to comply with the limits for a Class B digital device, pursuant to part 15 of the FCC Rules. These limits are designed to provide reasonable protection against harmful interference in a residential installation. This equipment generates, uses and can radiate radio frequency energy and, if not installed and used in accordance with the instructions, may cause harmful interference to radio communications. However, there is no guarantee that interference will not occur in a particular installation. If this equipment does cause harmful interference to radio or television reception, which can be determined by turning the equipment off and on, the user is encouraged to try to correct the interference by one or more of the following measures:

- Reorient or relocate the receiving antenna.
- Increase the separation between the equipment and receiver.
- Connect the equipment into an outlet on a circuit different from that to which the receiver is connected.
- Consult the dealer or an experienced radio/TV technician for help.

This device complies with part 15 of the FCC Rules. Operation is subject to the following two conditions: (1) This device may not cause harmful interference, and (2) this device must accept any interference received, including interference that may cause undesired operation.

# GOALZERO.COM

JG071720V2